

LUNERA HID LED LAMP

LED Replacement for High Intensity Discharge Lamps

[20,000lm / 15,000lm / 9,000lm / 4,500lm]

E39 Mogul-Base - Vertical Mount - Line Driven



Description

The Lunera HID LED lamp is a Line Driven (ballast bypassed) LED replacement for Metal Halide (MH) and High Pressure Sodium (HPS) lamps with an E39 mogul base. This lamp replaces 400W ~ 175W MH and HPS lamps in lighting applications such as High Bay, Low Bay and Parking Garages.

Lunera HID LED lamps feature a significantly lower energy consumption than conventional High Intensity Discharge (HID) lamps. These lamps deliver over 60% energy savings and have a rated life of 50,000 hours – 3 times longer than that of HID lamps. Its built-in universal driver allows lamp operation at 120V ~ 277V.

The Lunera HID LED lamp is available in a range of color temperatures including 3500K, 4000K and 5000K. Lamp configuration options include a 10% uplight for the 9,000 and 4,500 lumen products. It delivers consistent light levels across its long life, which results in a high quality lighting experience for the building's occupants.

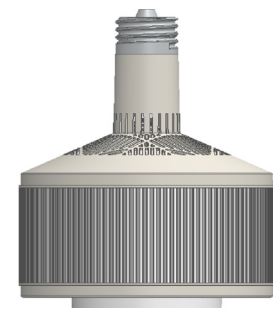

20,000lm
15,000lm
V

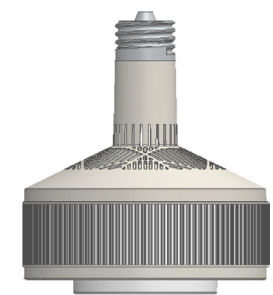

9,000lm
4,500lm
VS, VSU

Features

- Replaces 400W ~ 175W High Intensity Discharge (MH and HPS) lamps
- Line Driven (ballast bypassed) lamp; supports 120V ~ 277V
- Works well in enclosed fixtures
- Up to 20,000, 15,000, 9,000 and 4,500 lumens fixture delivered light output
- Yields 60%-80% energy savings
- >80 CRI
- CCT 3500K, 4000K and 5000K
- Supports E39/EX39 mogul base HID sockets
- Thermal IQ to support ambient temperatures up to 150°F
- Uplight Option with 10% uplight illumination for 9,000 and 4,500 lumen products (VSU)



Ordering Information

Example: SN-V-E39-L-20KLM-840-G3

Series	Version	Socket Type	Power Supply	Lamp Lumens	CCT	Generation
SN: Lunera HID LED	V: Vertical 20KLM / 15KLM VS: Vertical Short 9KLM / 4.5KLM VSU: Vertical Short Uplight 9KLM / 4.5KLM	E39: Fits in mogul-base (E39/EX39) HID socket	L: Line Driven (ballast bypassed) 120V ~ 277V	20KLM: 20,000lm 15KLM: 15,000lm 9KLM: 9,000lm 4.5KLM: 4,500lm	835: 80CRI / 3500K 840: 80CRI / 4000K 850: 80CRI / 5000K	G3: 3rd Generation

PROJECT	CONTACT	MODEL NO.
REFERENCE NO.	QUANTITY	DATE

For Technical Support:

www.lunera.com

T (650) 241-3874

1 of 5

<https://lunera.com/freshdesk.com/support/home>

Performance Specifications - Vertical Mount Lamp - 20,000lm / 15,000lm

	20,000 lumens	15,000 lumens
Illumination		
Color Temperatures	3500K, 4000K, 5000K	3500K, 4000K, 5000K
Lumens	3500K: 20,800lm 4000K: 20,618lm 5000K: 21,920lm	3500K: 16,210lm 4000K: 15,764lm 5000K: 16,910lm
Color Consistency	Lunera TruColor proprietary process	Lunera TruColor proprietary process
Lumen Maintenance (L70)	50,000+ hours life	50,000+ hours life
Electrical System		
Input Voltage	120V - 277V [Line Driven]	120V - 277V [Line Driven]
Average Lamp Power	230W	164W
Lamp Wattage Replaced	400W/320W/310W/250W	400W/320W/310W/250W
Physical		
Dimensions (H x W)	9.88" x 6.31"	9.88" x 6.31"
Weight	2.75lb	2.75lb
Housing and Finish	Painted	Painted
Heat Sink Size	6"	6"
Configuration	Vertical Standard Body/Heatsink (V)	Vertical Standard Body/Heatsink (V)
Lens	Clear	Clear
Environment		
Ambient Temperature	-40°F to 150°F*	-40°F to 150°F*
Humidity Rating	Damp OK, no direct water spray	Damp OK, no direct water spray
Fixture Type	Open or enclosed	Open or enclosed
Installation		
Socket Type	Fits vertical mount mogul base (E39/EX39) HID socket	Fits vertical mount mogul base (E39/EX39) HID socket
Certifications & Qualifications		
UL	Classified / Recognized US, CAN	Classified / Recognized US, CAN
RoHS Compliant	Contains no lead or mercury	Contains no lead or mercury
LM79, LM80, IES Files	Available	Available
DesignLights Consortium	DLC Listed	DLC Listed
Warranty		
Warranty	5 years	5 years

*Thermal IQ is a proprietary Lunera technology which enables the Susan Lamp to operate reliably up to 150°F ambient by dimming itself at extreme temperatures based upon thermal characteristics of the fixture in which it has been installed.

*Lamp dimming profiles subject to dimmer type and environmental conditions. Contact Lunera for more detailed information.

Performance Specifications - Vertical Mount Lamp - 9,000lm / 4,500lm

	9,000 lumens	4,500 lumens
Illumination		
Color Temperatures	3500K, 4000K, 5000K	3500K, 4000K, 5000K
Lumens	3500K: 8,817lm 4000K: 8,794lm 5000K: 9,170lm	3500K: 4,644lm 4000K: 4,800lm 5000K: 4,911lm
Color Consistency	Lunera TruColor proprietary process	Lunera TruColor proprietary process
Lumen Maintenance (L70)	50,000+ hours life	50,000+ hours life
Electrical System		
Input Voltage	120V - 277V [Line Driven]	120V - 277V [Line Driven]
Average Lamp Power	103W	58W
Lamp Wattage Replaced	250W/175W/150W/100W/70W	250W/175W/150W/100W/70W
Physical		
Dimensions (H x W)	8.59" x 6.31"	8.59" x 6.31"
Weight	1.9lb	1.9lb
Housing and Finish	Painted	Painted
Heat Sink Size	6" Small	6" Small
Configuration	Vertical Short Body/Heatsink (VS)	Vertical Short Body/Heatsink (VS)
Lens	Frosted or Type V Option	Frosted or Type V Option
Environment		
Ambient Temperature	-40°F to 150°F*	-40°F to 150°F*
Humidity Rating	Damp OK, no direct water spray	Damp OK, no direct water spray
Fixture Type	Open or enclosed	Open or enclosed
Installation		
Socket Type	Fits vertical mount mogul base (E39/EX39) HID socket	Fits vertical mount mogul base (E39/EX39) HID socket
Certifications & Qualifications		
UL	Classified / Recognized US, CAN	Classified / Recognized US, CAN
RoHS Compliant	Contains no lead or mercury	Contains no lead or mercury
LM79, LM80, IES Files	Available	Available
DesignLights Consortium	DLC Listed	DLC Listed

Warranty

Warranty	5 years	5 years
----------	---------	---------

*Thermal IQ is a proprietary Lunera technology which enables the Susan Lamp to operate reliably up to 150°F ambient by dimming itself at extreme temperatures based upon thermal characteristics of the fixture in which it has been installed.

*Lamp dimming profiles subject to dimmer type and environmental conditions. Contact Lunera for more detailed information.

Photometry

Optical data is based on performance of bare lamps.

Polar Candela Distribution [20,000lm / 15,000lm] - High Bay

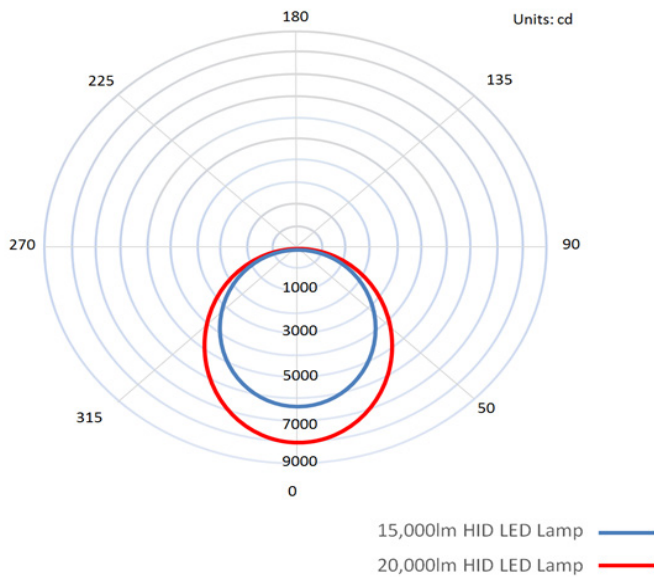



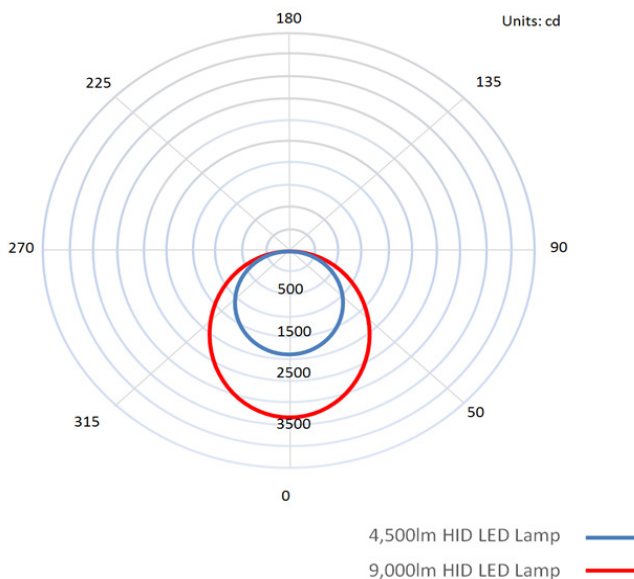

Polar Candela Distribution [9,000lm / 4,500lm] - Low Bay

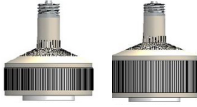

Intended Applications

The Lunera HID LED lamp is designed to replace Metal Halide (MH) and High Pressure Sodium (HPS) lamps in the following compatible applications:

Wattage Compatibilities	Sockets	Power Source	Mount
Lunera HID LED Mogul (E39) Base  400W -70W MH or HPS	E39 / EX39 Mogul 	120V- 277V Line Voltage 	Vertical Mount Fixture Type  High Bay Low Bay

Application Notes

The Lunera HID LED lamp can be used in open and fully enclosed fixtures.

This device is NOT rated for use with dimmers.

Contact Lunera for luminaire level IES files with high bay and low bay DLC referenced fixtures.

This lamp can be installed with 2-wire trailing-edge dimmers. Do NOT over-load the dimmer [Contact Lunera for more info.]

This product is NOT intended for use with emergency lighting or for emergency lighting.

Warranty will be voided if the product is installed into/with the following:

- Installed with leading edge and other incompatible dimmers
- Line Voltage above 277V (e.g. 280V, 347V, or 480V)
- LED Driver

Uplight version of this lamp is available for 9Klm and 4.5Klm.

Caution

Turn power off when installing this lamp.

Do NOT install this lamp into line voltage above 277VAC.

Product Dimensions

Measurements are exact. Dimensions are shown in millimeters and inches. Please contact your Lunera representative for other product dimensions.

Vertical Standard Body/Heatsink (V) E39 Lamp 20,000lm / 15,000lm

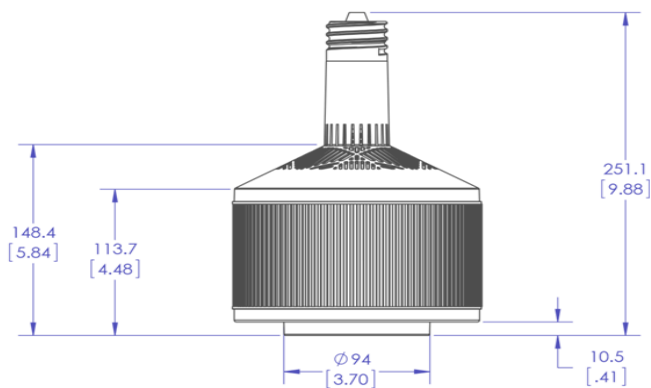
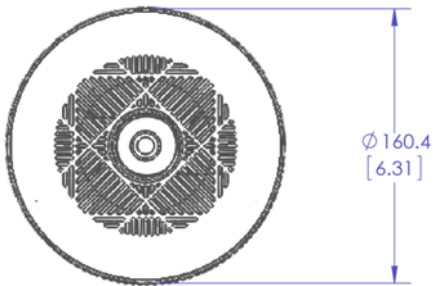

Sample Part Numbers:

SN-V-E39-L-20KLM-8XX-G3
SN-V-E39-L-15KLM-8XX-G3

'XX': may be 35 (3500K), 40 (4000K), or 50 (5000K)

Vertical Short Body/Small Heatsink (VS) E39 Lamp 9,000lm / 4,500lm

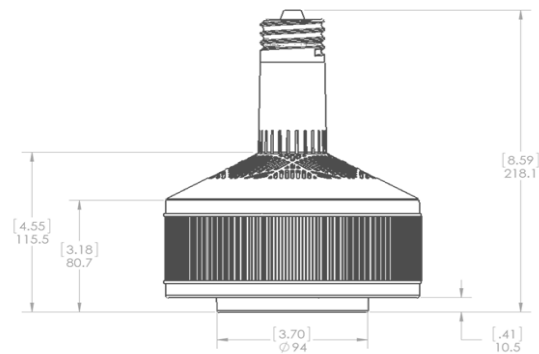
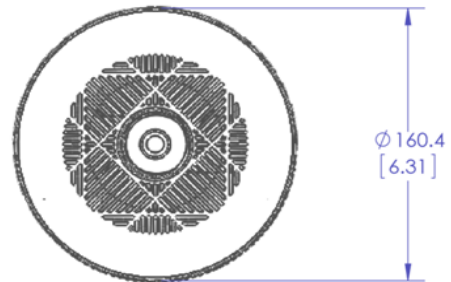

Sample Part Numbers:

SN-VS-E39-L-9KLM-8XX-G3
SN-VS-E39-L-4.5KLM-8XX-G3

'XX': may be 35 (3500K), 40 (4000K), or 50 (5000K)

CAUTION

Turn off power when installing the Lamp.

For FAQ and Technical Support, please visit:
<https://lunera.freshdesk.com/support/home>

© 2016 Lunera Lighting, Inc. All Rights Reserved. Lunera and the Lunera logo are registered trademarks of Lunera Lighting, Inc. All other trademarks are the property of their respective owners.

Specifications are subject to change without notice. This document is for informational purposes only.

For Technical Support:
<https://lunera.com/freshdesk.com/support/home>

www.lunera.com

T (650) 241-3874

R120616 © 2016 Lunera® Lighting

